

RTS cable-free tool setting probe



Fast and accurate

on-machine tool setting and
broken tool detection



Superior

communication capability



Outstanding

performance for less scrap
and higher profits



RTS – innovative process control

Tackle process variation at source, and reap the rewards

The higher the degree of human involvement in the manufacturing process, the higher the risk for error. Automated in-process measurement using Renishaw probes can help **eliminate the risk**. The Renishaw RTS radio tool setter can facilitate the following measures for enhanced management of your production leading to an **increase in your profits**.

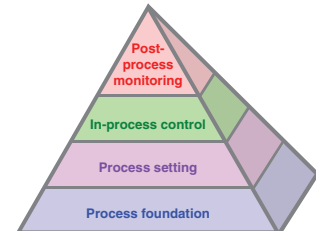

Process setting

Automated on-machine tool setting eliminates manual setting operations.

- Establish height offsets and check tool length is within tolerance
- Determine diameter when spinning to establish tool size offsets
- Compensate for dynamic effects on the machine tool
- Eliminate manual setting errors and data entry
- Set up faster, improve quality and reduce scrap

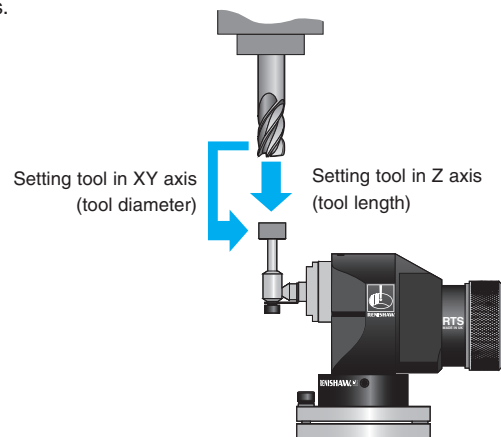

In-process control

Automated tool condition monitoring.

- Improve process capability and traceability
- Compensate for environmental and machine conditions
- Detect broken tools in-process
- Reduce non-productive time and scrap
- Increase productivity and profits

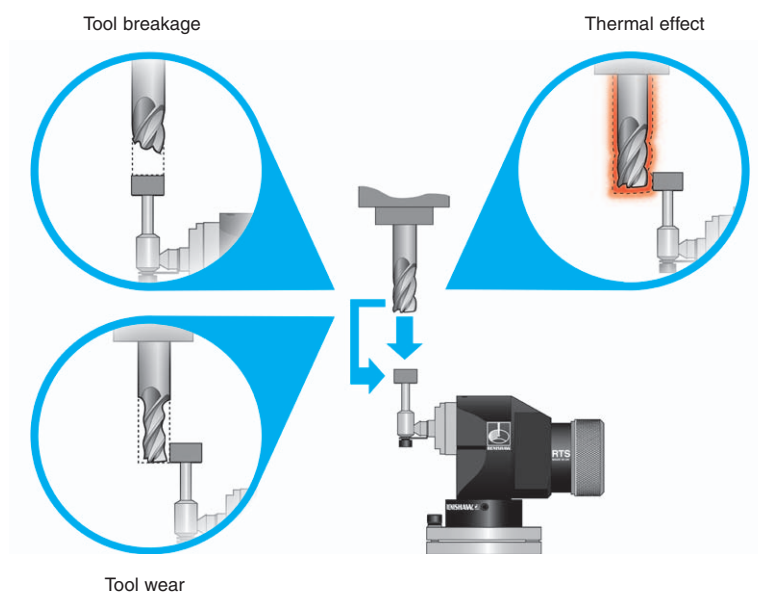

Tool setting pays...

Machine tools that are optimised to cut more metal, more reliably and more accurately will quickly **maximise productivity, profits and your competitive edge.**



Automated tool setting with the Renishaw RTS tool setting probe is up to 10 times faster than manual methods, which means immediate and **significant cost savings.**

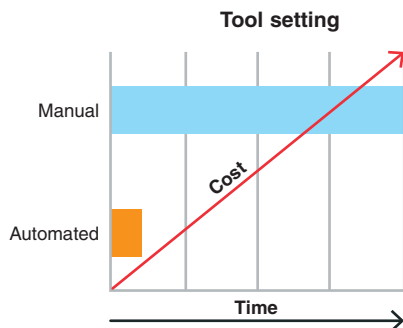

Scrap and rework reduce productivity and profits. The Renishaw RTS tool setting probe helps guarantee “right first time” parts which means **reduced waste and increased profits.**

RTS key features

- Rapid measurement of tool length and diameter on a variety of machine tools
- Cable-free for unrestricted machine movement and ease of installation
- Trigger logic™ for quick and easy set up
- Delivers interference free transmission through the use of Frequency hopping spread spectrum (FHSS)
- Globally recognised 2.4 GHz waveband — compliant with radio regulations in all major markets

... the Renishaw way

Renishaw, an established world leader in metrology solutions invented the touch-trigger probe in the 1970s.

Decades of customer focus and investment in development, coupled with our own manufacturing experience enables us to provide **innovative** and **exceptional products** that are unmatched for technical excellence and performance.

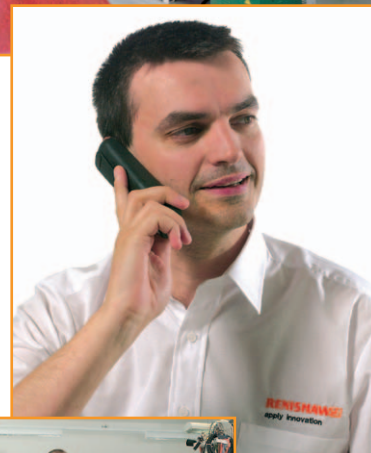

RTS – more than just tool setting!

With Renishaw's RTS enabling faster and more accurate tool setting the additional in-process benefits are significant and easy to understand. During machining processes, dimensional accuracy is dependent upon a number of variables, including: tool size deviation, tool/holder run-out and tool breakage.

Renishaw RTS tool setter can:

- compensate for variation during the machining process
- update the machine's controller automatically to account for actual effects, e.g. tool wear
- automatically stop the process when broken tools are detected
- reduce rework, concessions and scrap

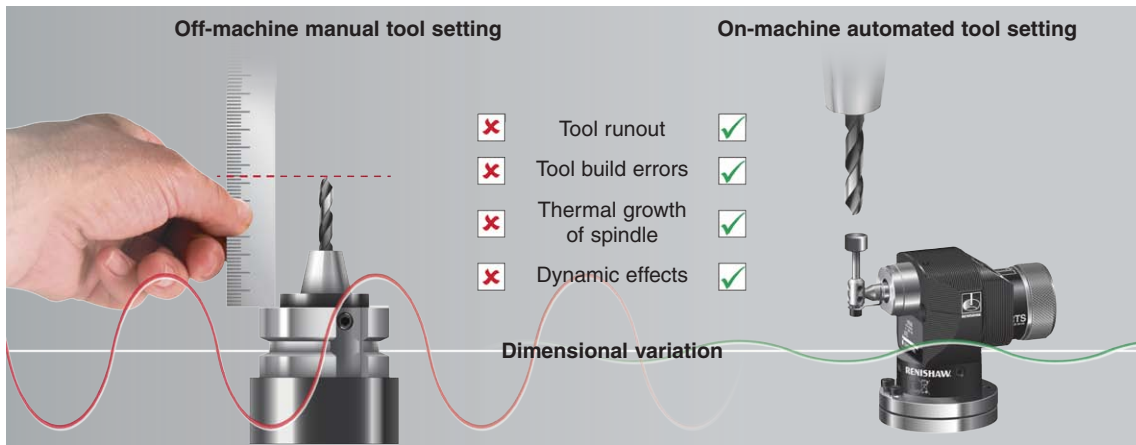

In addition to the obvious performance and commercial benefits of a single RTS installation, even greater productivity enhancements are possible when RTS is integrated with other Renishaw radio products.

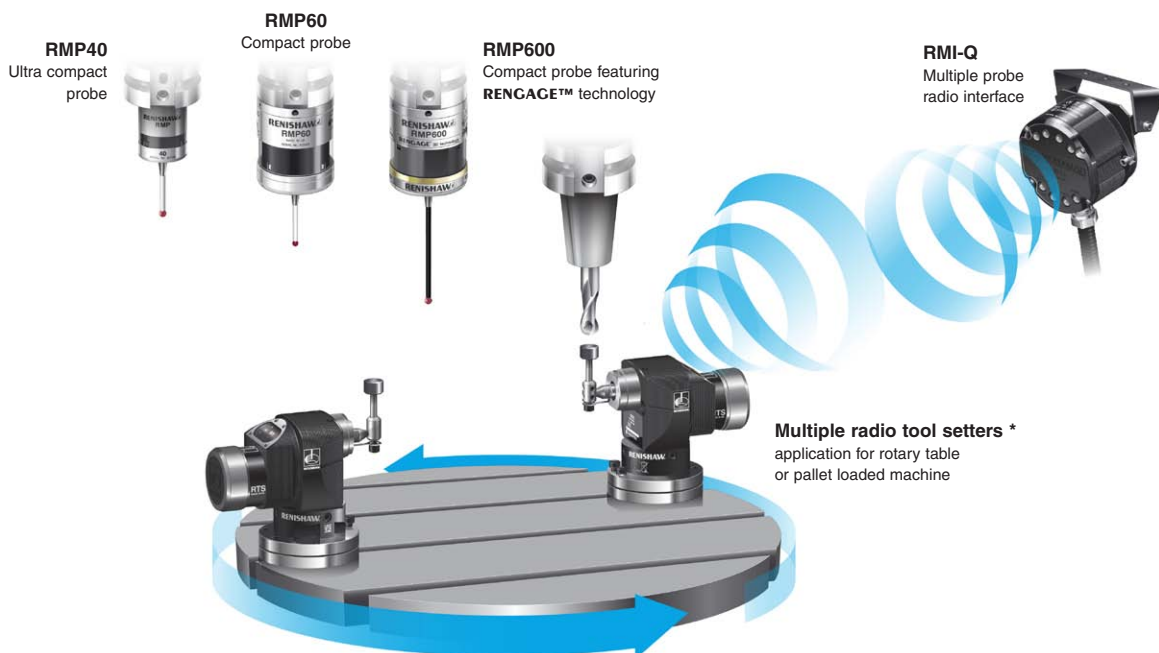

* RTS is a second generation Renishaw radio probe - see RMI-Q brochure for further information on compatibility with other Renishaw probes

RTS and RMI-Q optimised for reliable and safe operation

The benefits of FHSS

In addition to its high performance optical systems Renishaw offers a reliable radio solution for larger machines and/or installations where line-of-sight applications are not possible.

Frequency hopping spread spectrum (FHSS) is a robust and proven technology, that enables devices to jump from channel to channel.

Unlike other protocols which may require manual intervention, Renishaw's products will continue to work as other devices such as Wi-Fi, Bluetooth and microwave enter the same environment.

Operating within the recognised 2.4 GHz frequency band, RMI-Q is compliant with radio regulations in all major markets. It is the preferred choice of many leading machine builders and experienced users.



Ease of use and reliability

Unique to Renishaw, Trigger Logic™ is a simple method enabling the user to quickly adjust probe mode settings for specific applications.

Constructed from the highest grade materials, Renishaw probes are robust and reliable in the harshest environments including shock, vibration, temperature extremes and even continual liquid immersion.



Engineered for superior performance

Through the optimisation of transmission and power, RMI-Q partnered with Renishaw's radio transmission probes provides high operational integrity, long battery life and the superior capabilities required in demanding machine shop environments.

- Multiple Renishaw radio probes will reliably co-exist in machine shops of any size
- Combine up to four second generation* probes and/or tool setters with a single RMI-Q
- Negligible interference from other radio sources ensures consistent and reliable performance
- Does not require a carefully managed radio/wireless environment
- Renishaw probes work with widely available "off-the-shelf" batteries

* Second generation radio probes are easily identified by a 'Q' symbol.

For further details, please refer to the *RTS data sheet H-5646-8200*.

About Renishaw

Renishaw is an established world leader in engineering technologies, with a strong history of innovation in product development and manufacturing. Since its formation in 1973, the company has supplied leading-edge products that increase process productivity, improve product quality and deliver cost-effective automation solutions.

A worldwide network of subsidiary companies and distributors provides exceptional service and support for its customers.

Products include:

- Additive manufacturing, vacuum casting, and injection moulding technologies for design, prototyping, and production applications
- Advanced material technologies with a variety of applications in multiple fields
- Dental CAD/CAM scanning and milling systems and supply of dental structures
- Encoder systems for high accuracy linear, angle and rotary position feedback
- Fixturing for CMMs (co-ordinate measuring machines) and gauging systems
- Gauging systems for comparative measurement of machined parts
- High speed laser measurement and surveying systems for use in extreme environments
- Laser and ballbar systems for performance measurement and calibration of machines
- Medical devices for neurosurgical applications
- Probe systems and software for job set-up, tool setting and inspection on CNC machine tools
- Raman spectroscopy systems for non-destructive material analysis
- Sensor systems and software for measurement on CMMs
- Styli for CMM and machine tool probe applications

For worldwide contact details, please visit our main website at www.renishaw.com/contact



RENISHAW HAS MADE CONSIDERABLE EFFORTS TO ENSURE THE CONTENT OF THIS DOCUMENT IS CORRECT AT THE DATE OF PUBLICATION BUT MAKES NO WARRANTIES OR REPRESENTATIONS REGARDING THE CONTENT. RENISHAW EXCLUDES LIABILITY, HOWSOEVER ARISING, FOR ANY INACCURACIES IN THIS DOCUMENT.

©2013 Renishaw plc. All rights reserved.

Renishaw reserves the right to change specifications without notice

RENISHAW and the probe symbol used in the RENISHAW logo are registered trade marks of Renishaw plc in the United Kingdom and other countries. apply innovation and names and designations of other Renishaw products and technologies are trade marks of Renishaw plc or its subsidiaries. All other brand names and product names used in this document are trade names, trade marks or registered trade marks of their respective owners.



H - 5646 - 8300 - 02 - A

Issued 0213 Part no. H-5646-8300-02-A